

CANDI GORDON

FASHION DESIGNER

candiskyegordon@gmail.com

(228) 596-8595

TABLE OF CONTENTS:

1. NULL: reconstructing the future
2. NIKE-0: a zero-waste pattern adaptation
3. NEW BALANCE: jaden + coco collaboration
4. DENIM: repurposed for sustainability
5. ELEMENT-0: zero-waste modular relief kit (WIP)

NULL: Reconstructing the Future

A Zero-Waste Collection

Null is a zero-waste collection that represents the blueprint for the future of fashion. All of these designs were created with no textile waste in an effort to reduce that customers don't have to come the 11.2 million tons created annually by the fashion industry. My goal is to create truly sustainable garments that are also fashionable, so that customers don't have to compromise aesthetics for sustainability. This system can be implemented in large scale production, unlike many other zero-waste patterns, and reduce our industry's pre-consumer textile waste by 20%. To change the world and the fashion industry, we must rethink the entire design system and rebuild it on a foundation of responsible and innovative design that will really make a difference. This is the future of fashion.

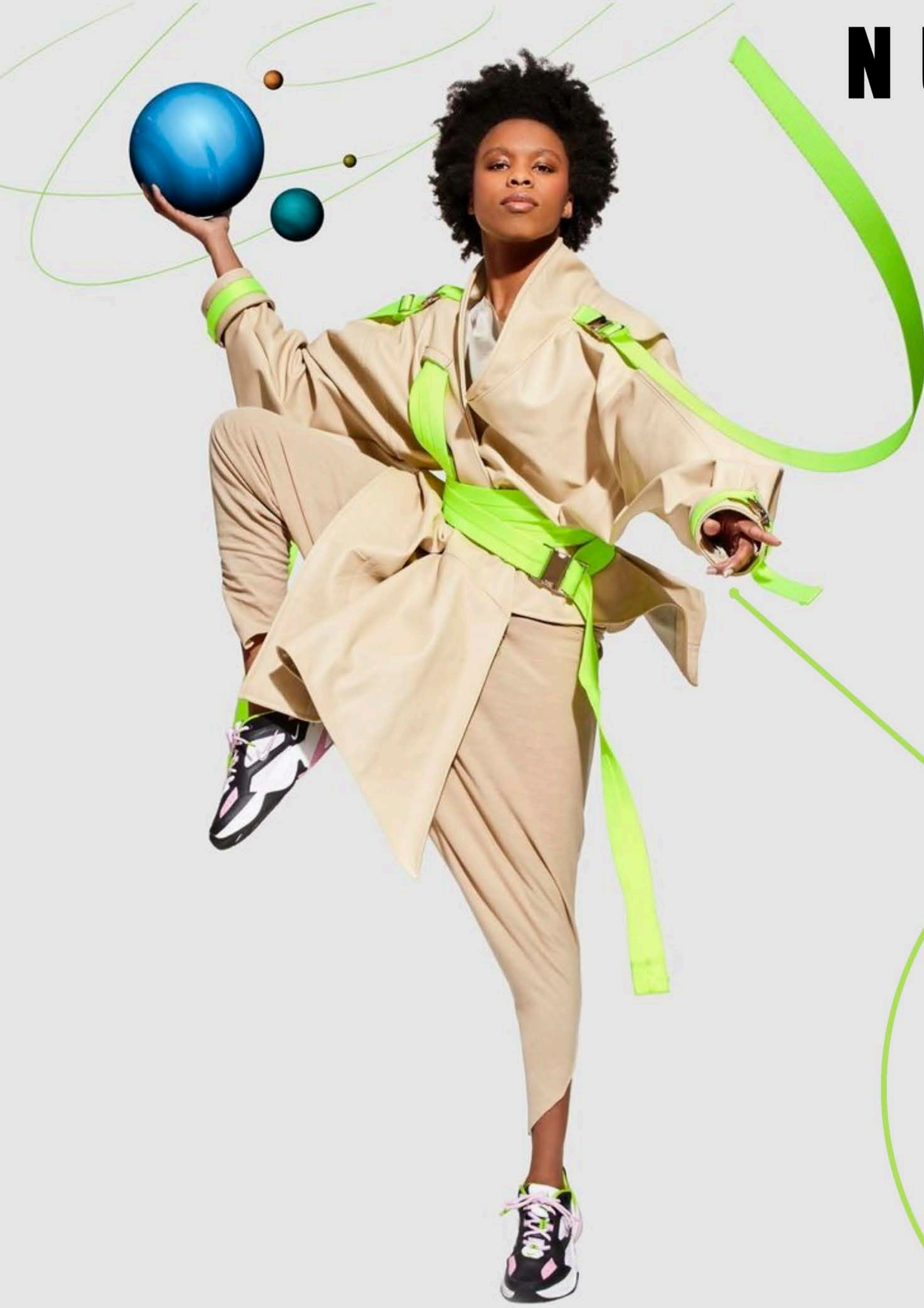
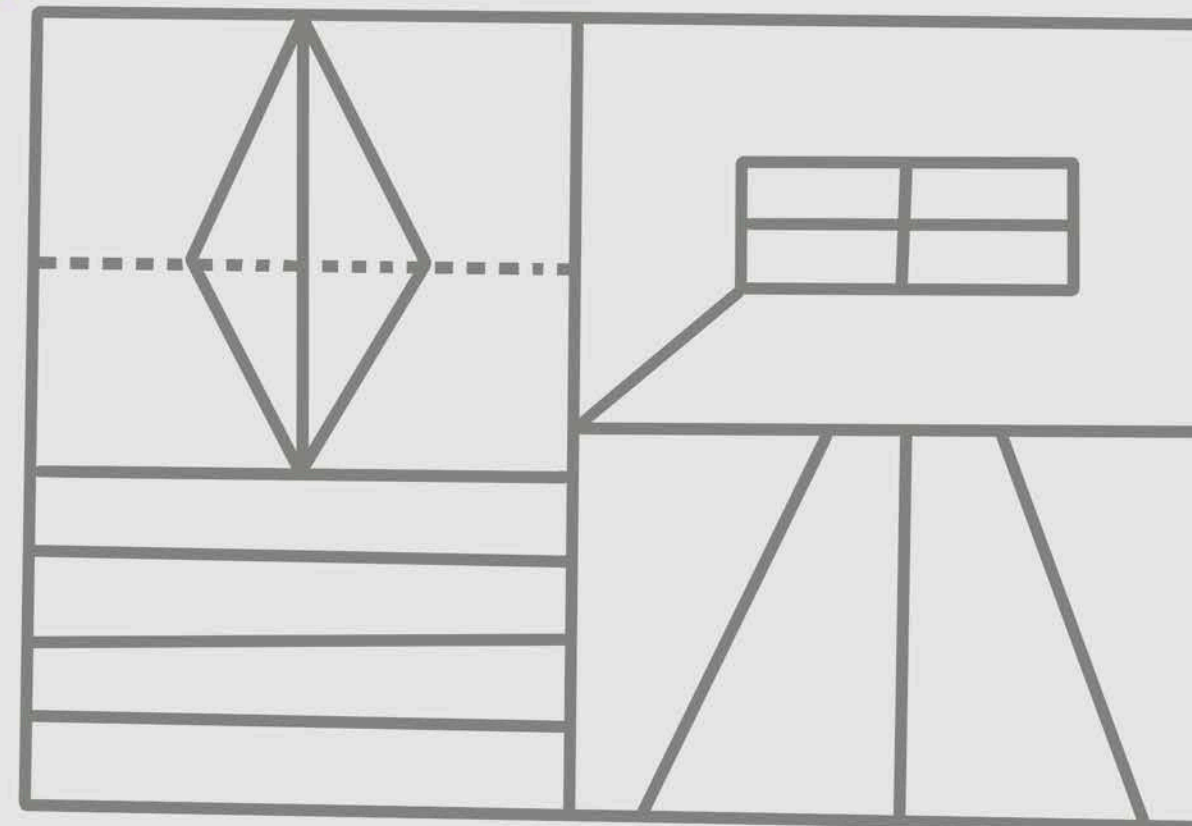

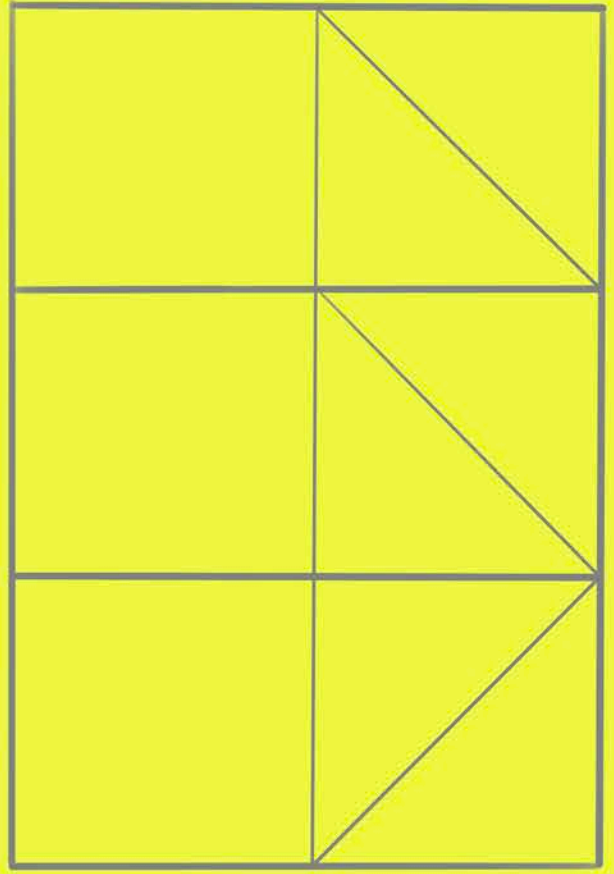
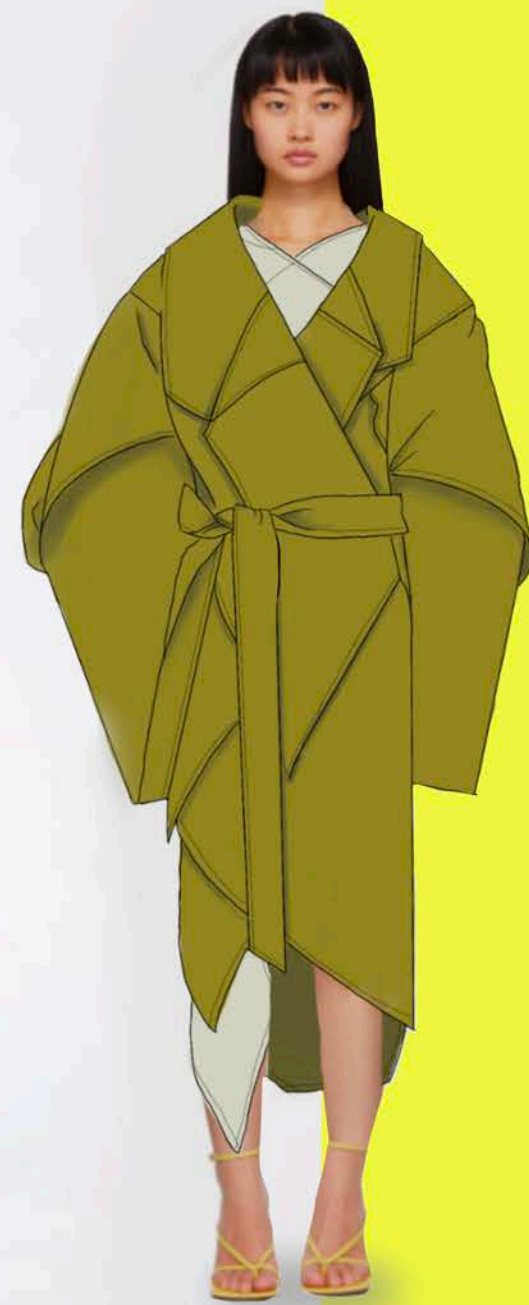
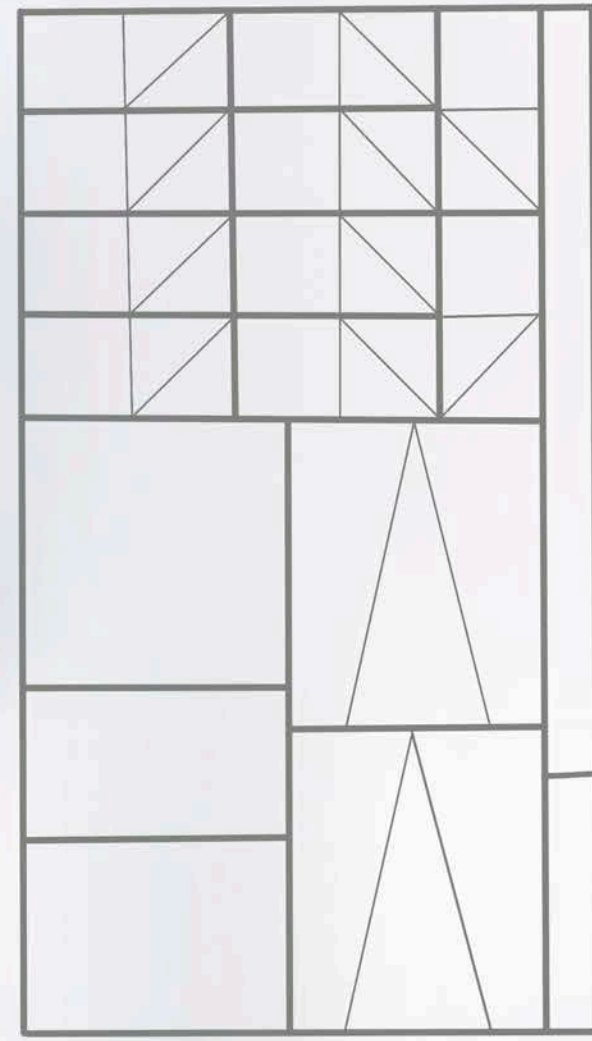

PROCESS

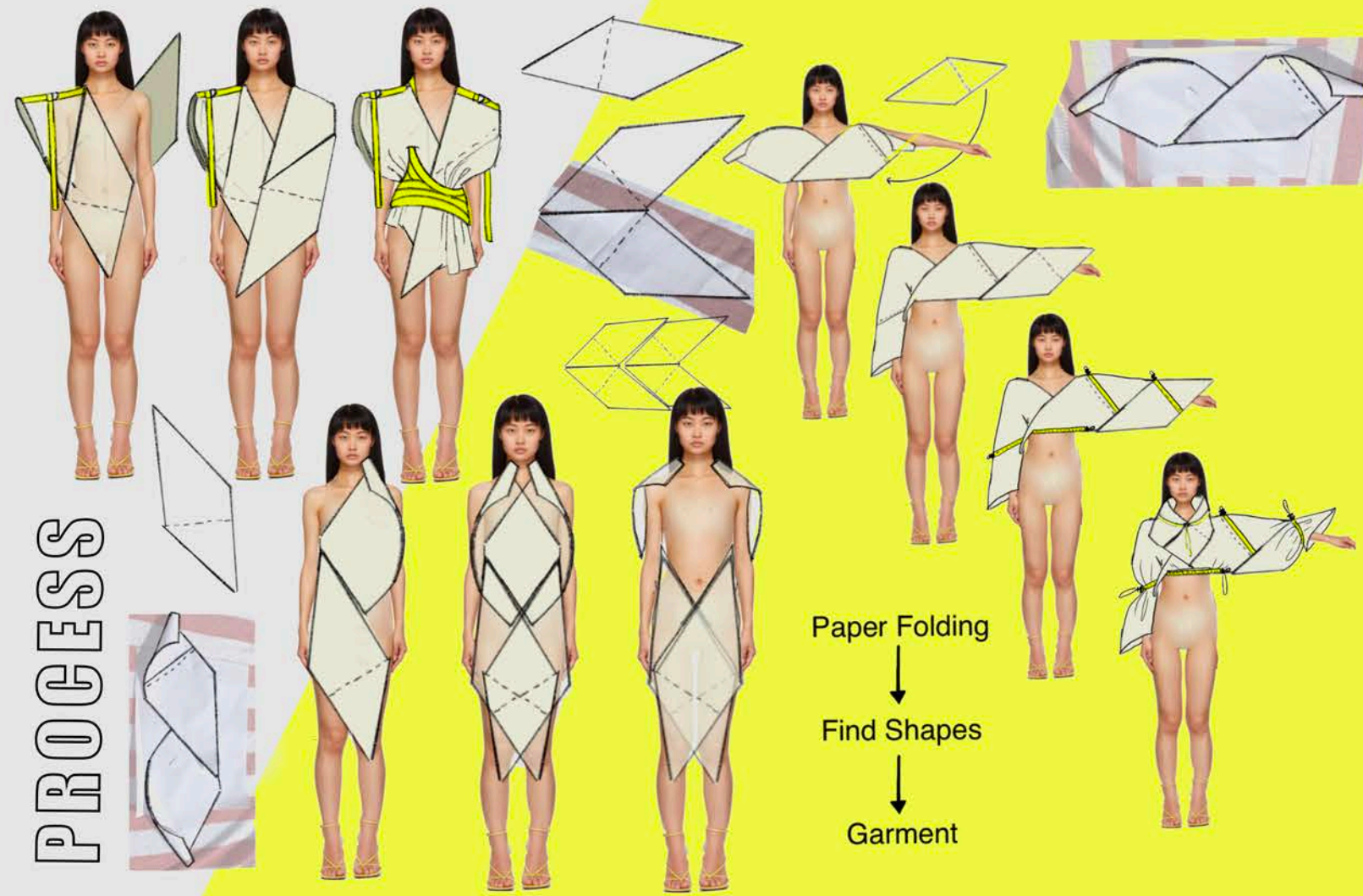

Paper Folding
↓
Find Shapes
↓
Garment

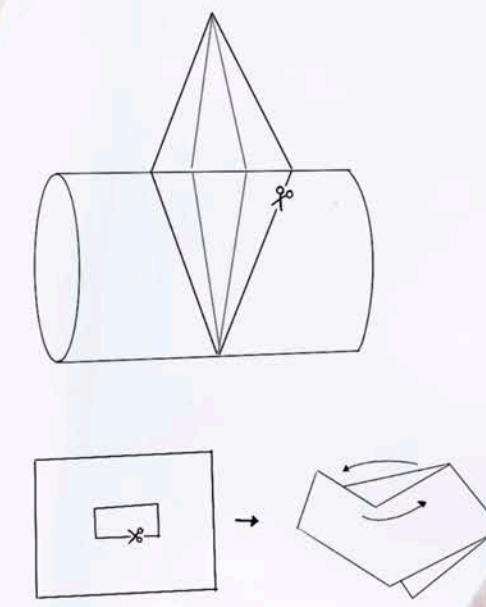
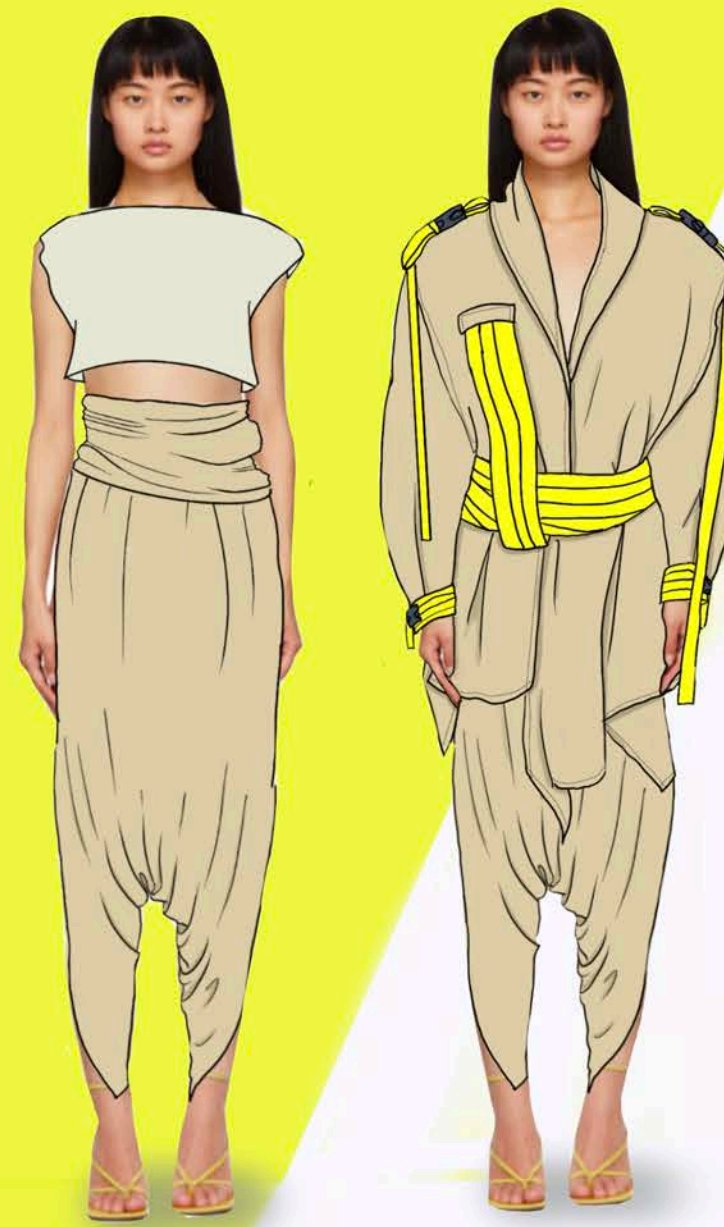



NIKE ZERO

Technical Practice Uniforms
with Zero Fabric Waste





OBJECTIVE: Create a Zero-Waste alternative to the mass produced Nike Pro Training Shirt that functions the same and has the same aesthetic, but no textile waste

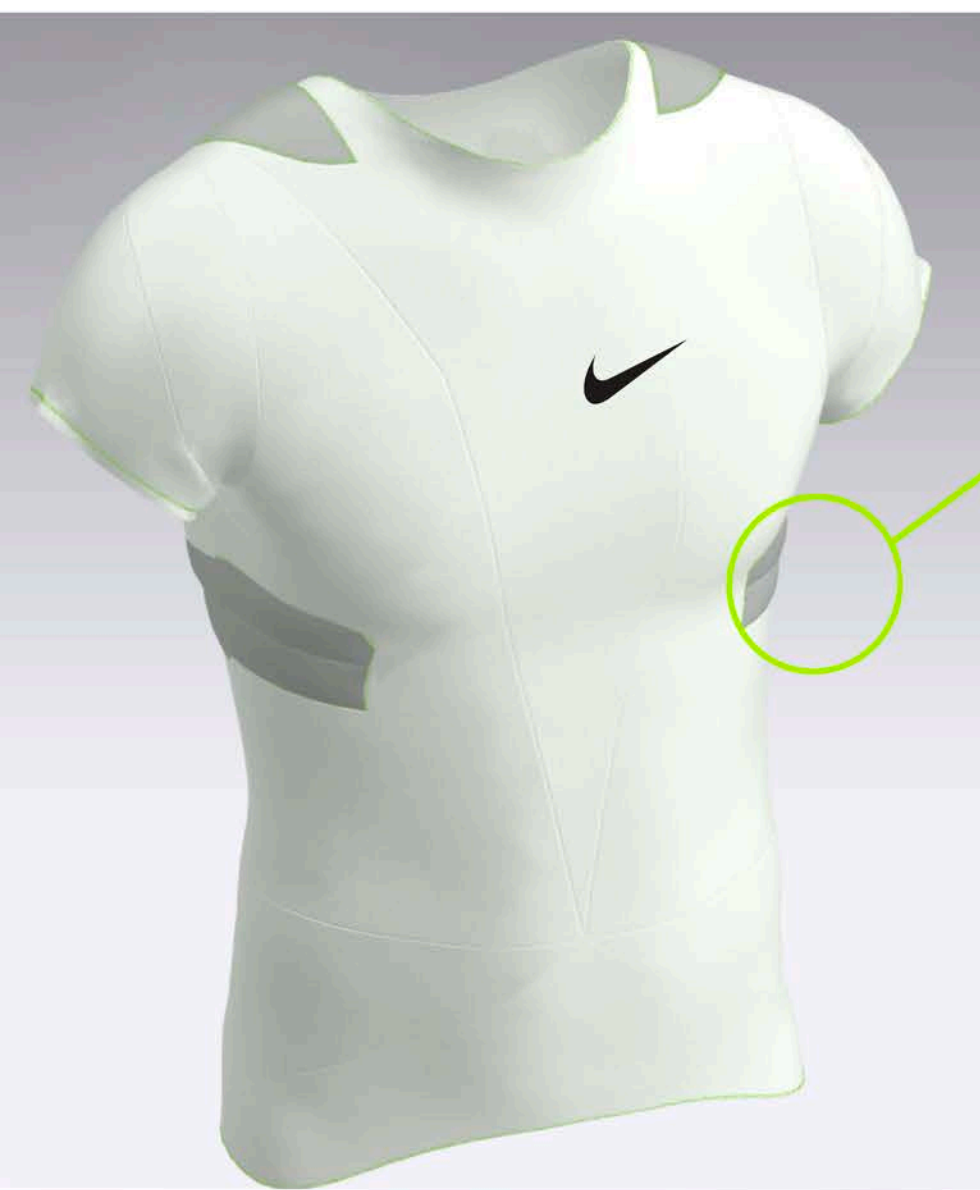

Protective Padding

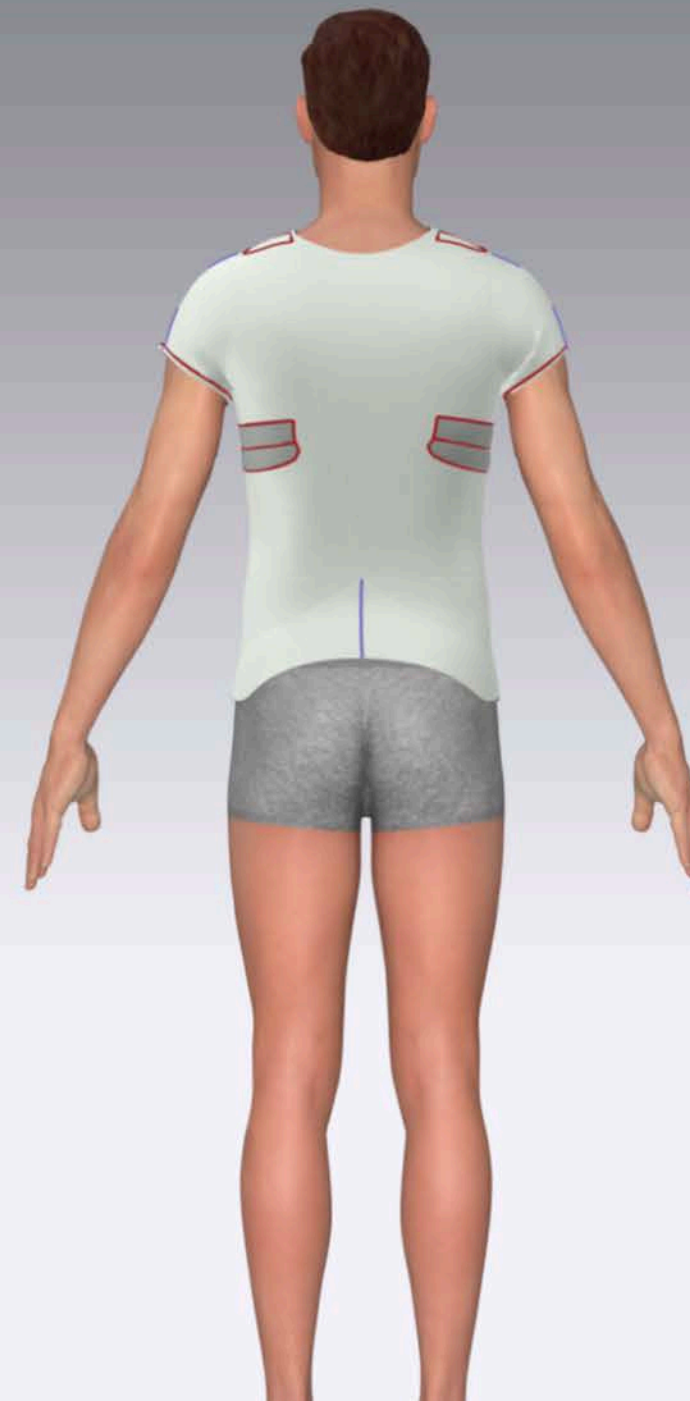
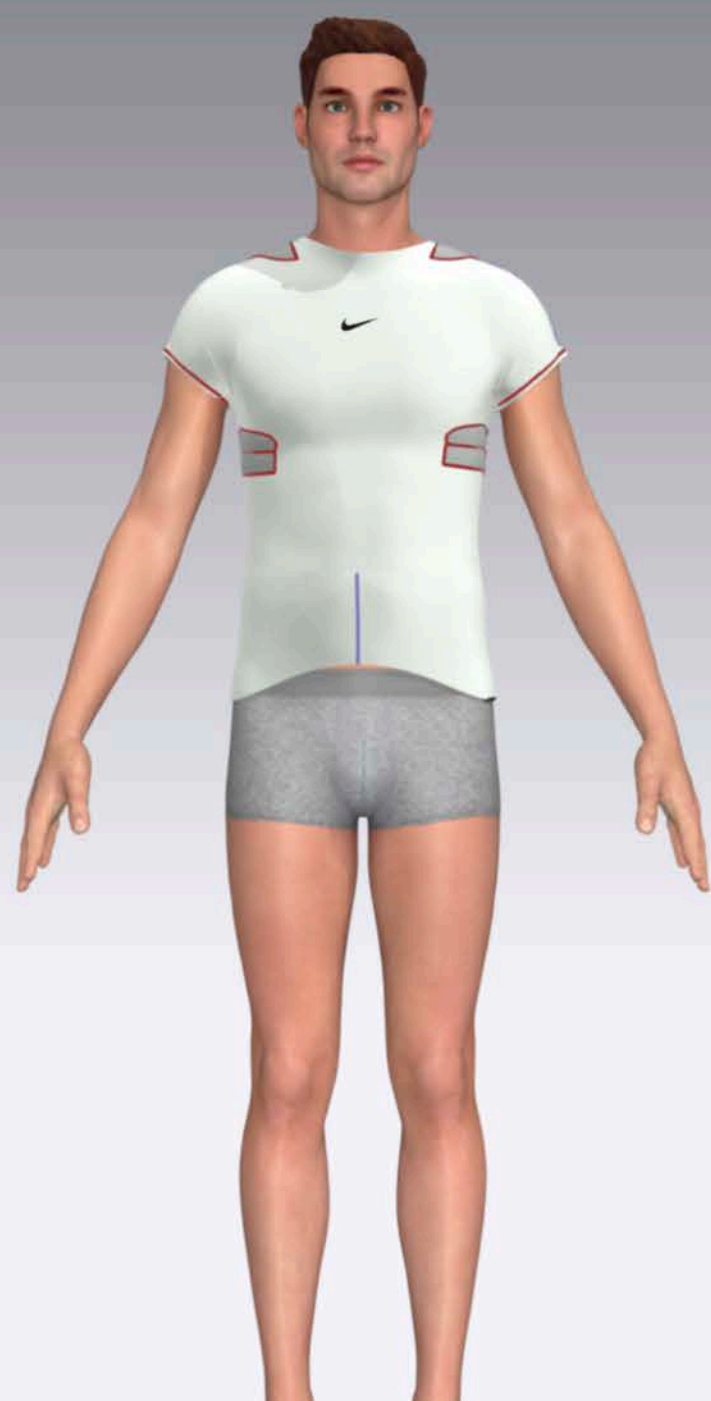
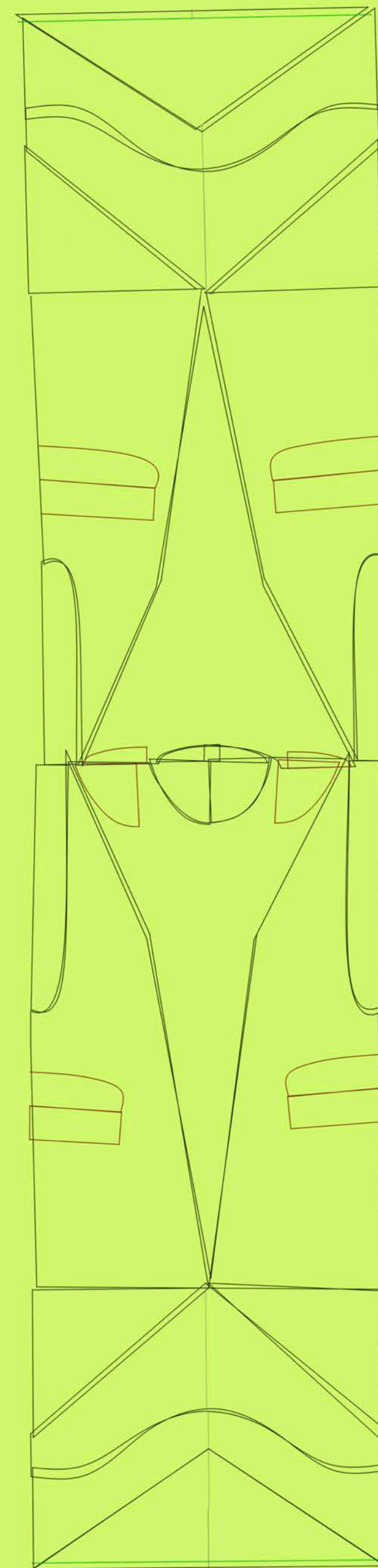
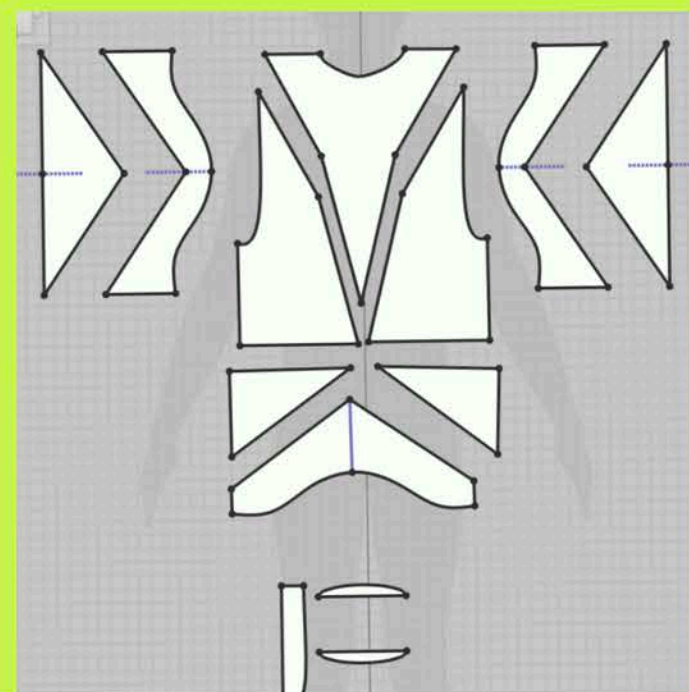

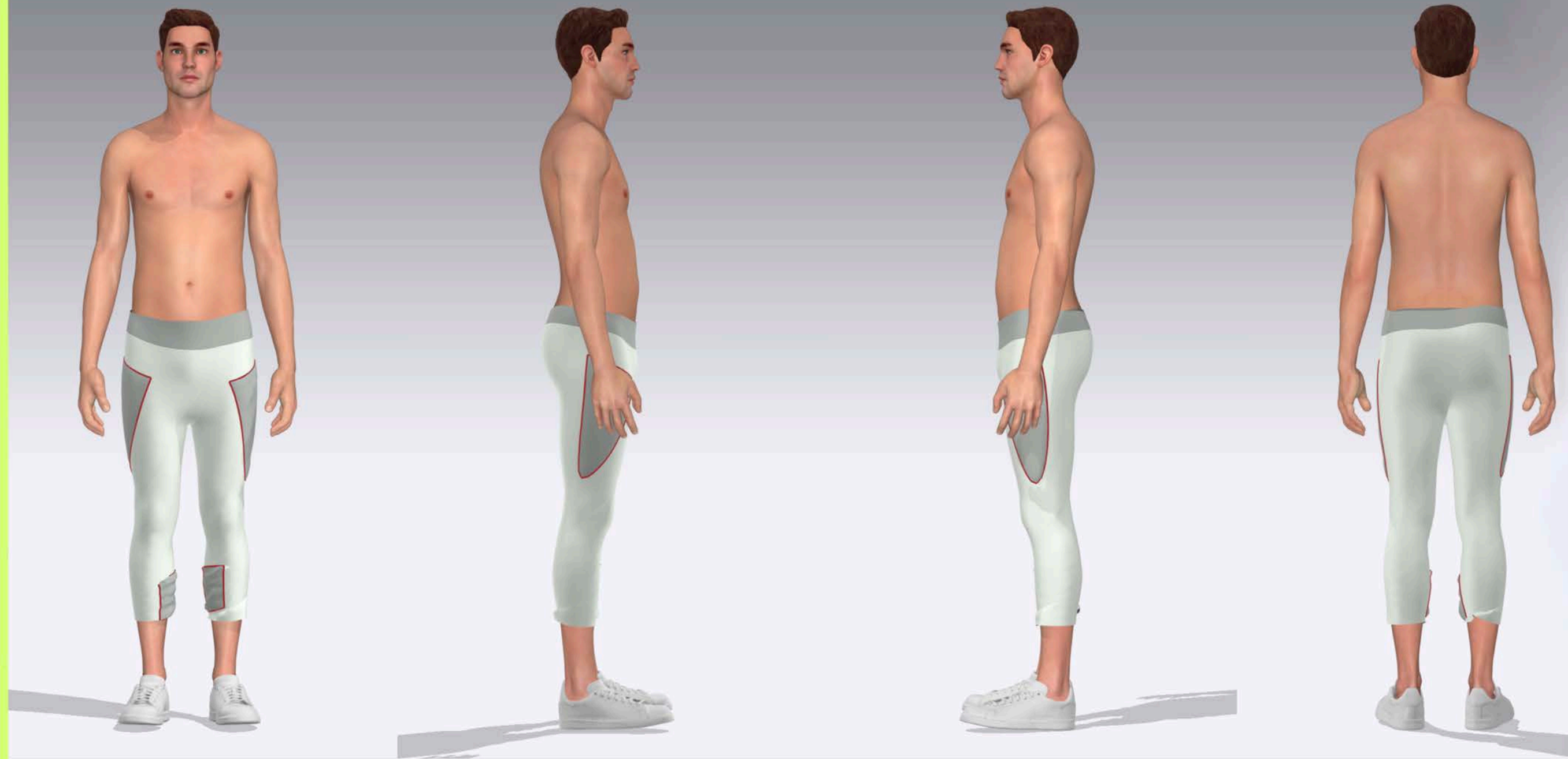
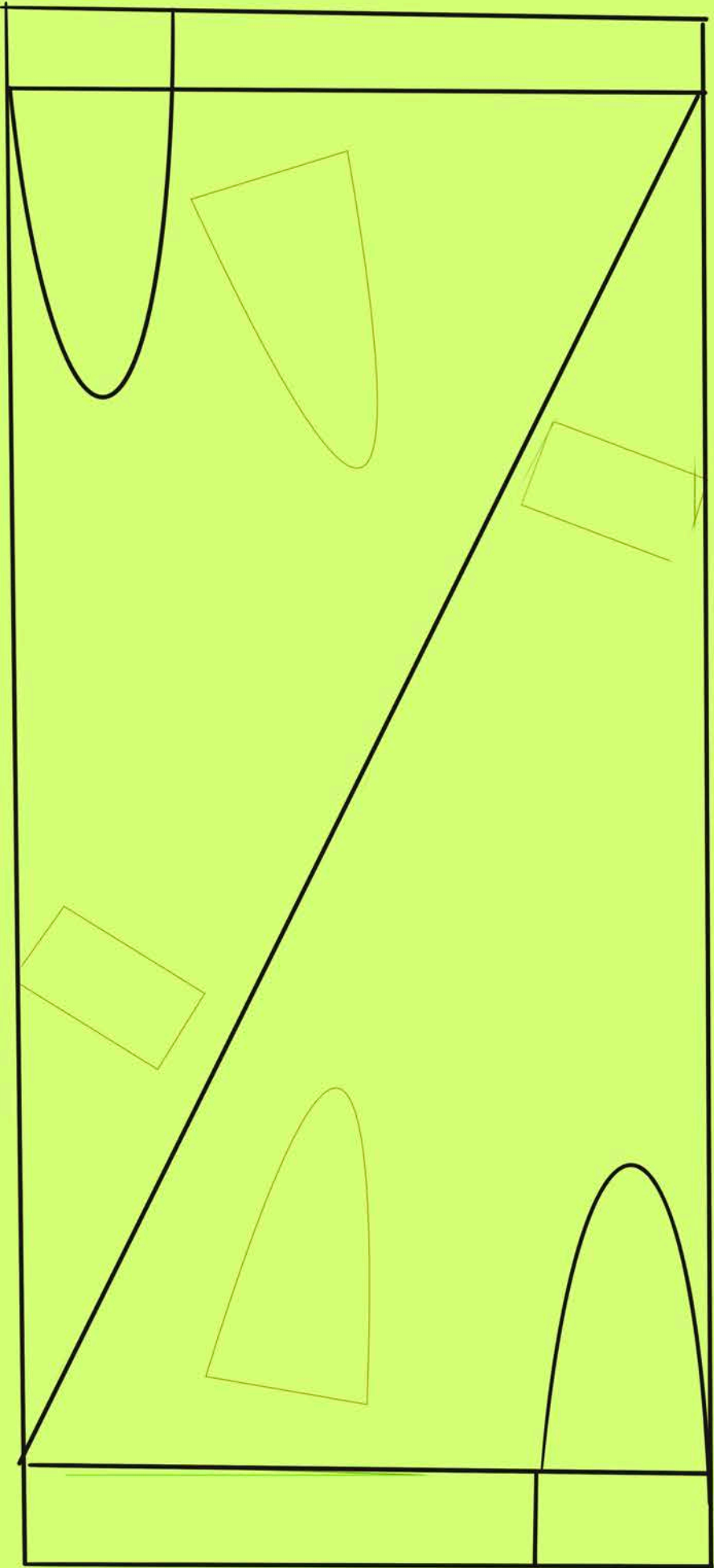

new balance

new balance



Laden

new balance



**PER
FOR
MA
NCE**

(n.): An act of staging or presenting a play, concert, or other form of Entertainment



**FUNCTION
PERFORMANCE**

(N): THE ACTION OR PROCESS OF CARRYING OUT OR ACCOMPLISHING A TASK, ACTION, OR FUNCTION.



Entertainment

**FUNCTION
FUNCTION**



COCO GAUFF AND JADEN SMITH ARE BOTH PERFORMERS. ONE PERFORMS ON THE COURT, THE OTHER ON THE STAGE. THIS INTERESTING RELATIONSHIP BETWEEN FUNCTION AND ENTERTAINMENT IS NECESSARY FOR TRUE PERFORMANCE. DART FROGS UTILIZE THEIR VIBRANT AND COLORFUL PATTERNS NOT ONLY FOR BEAUTY, BUT ALSO FOR PROTECTION. IN THE SAME WAY, LUXURY SPORTS CARS CREATE AESTHETICALLY PLEASING STYLE LINES FROM THEIR FUNCTIONAL VENTS AND ALSO A SLEEK SILHOUETTE THAT IS ALSO AERODYNAMIC. INSPIRED BY THESE OBJECTS THAT EMBODY BOTH FUNCTION AND ENTERTAINMENT, THIS NEW BALANCE COLLECTION FEATURES BRIGHT PATTERNS AND INTERESTING SHAPES THAT WILL ALSO ENHANCE COMFORT DURING ATHLETIC ACTIVITIES AND DAILY LIFE. NEW BALANCE IS FOR THE PERFORMER.

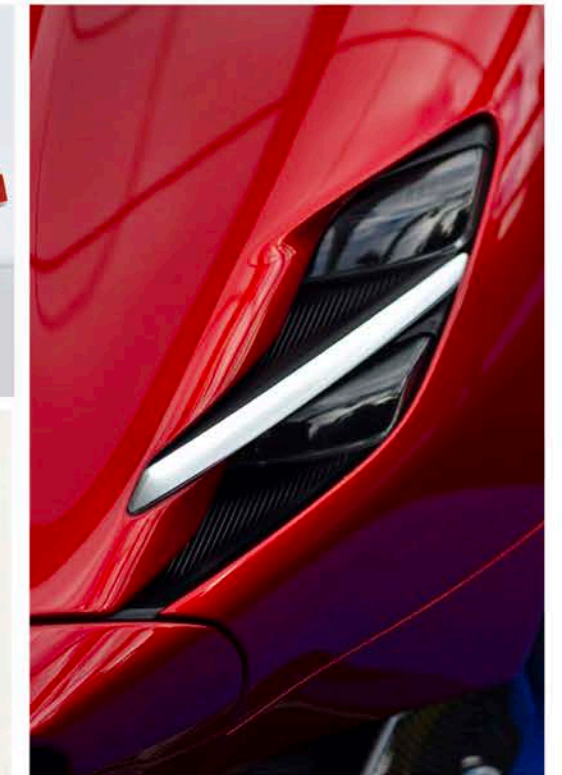
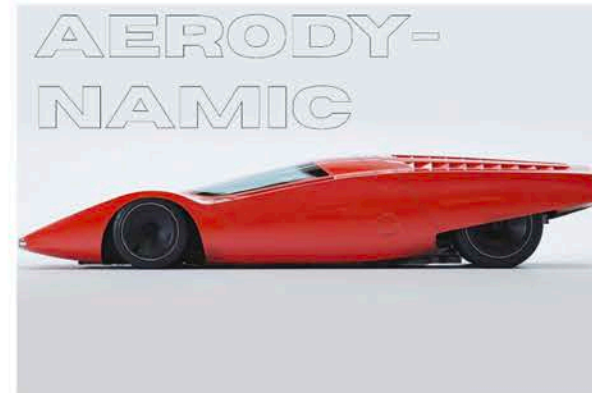

**COLOR
FUL
PRINTS**

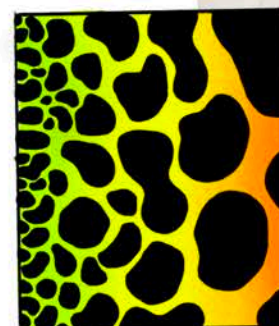

VENTS



**ON-COURT
STATEMENT**



**PRACTICE
LOOK**



LIFESTYLE



**HIGH FASHION-
LOOK**

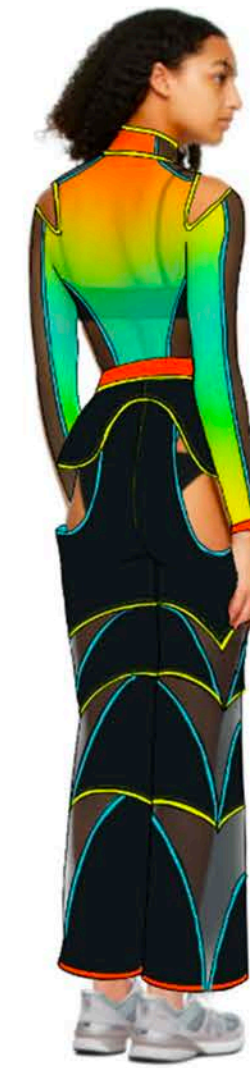

**COMMERCIAL
LOOK**



new balance

Z E R O - W A S T E

R E P U R P O S E D

D E N I M



Objective: Create a garment and technical drawings with collaged denim



C
L
O
S
E
D

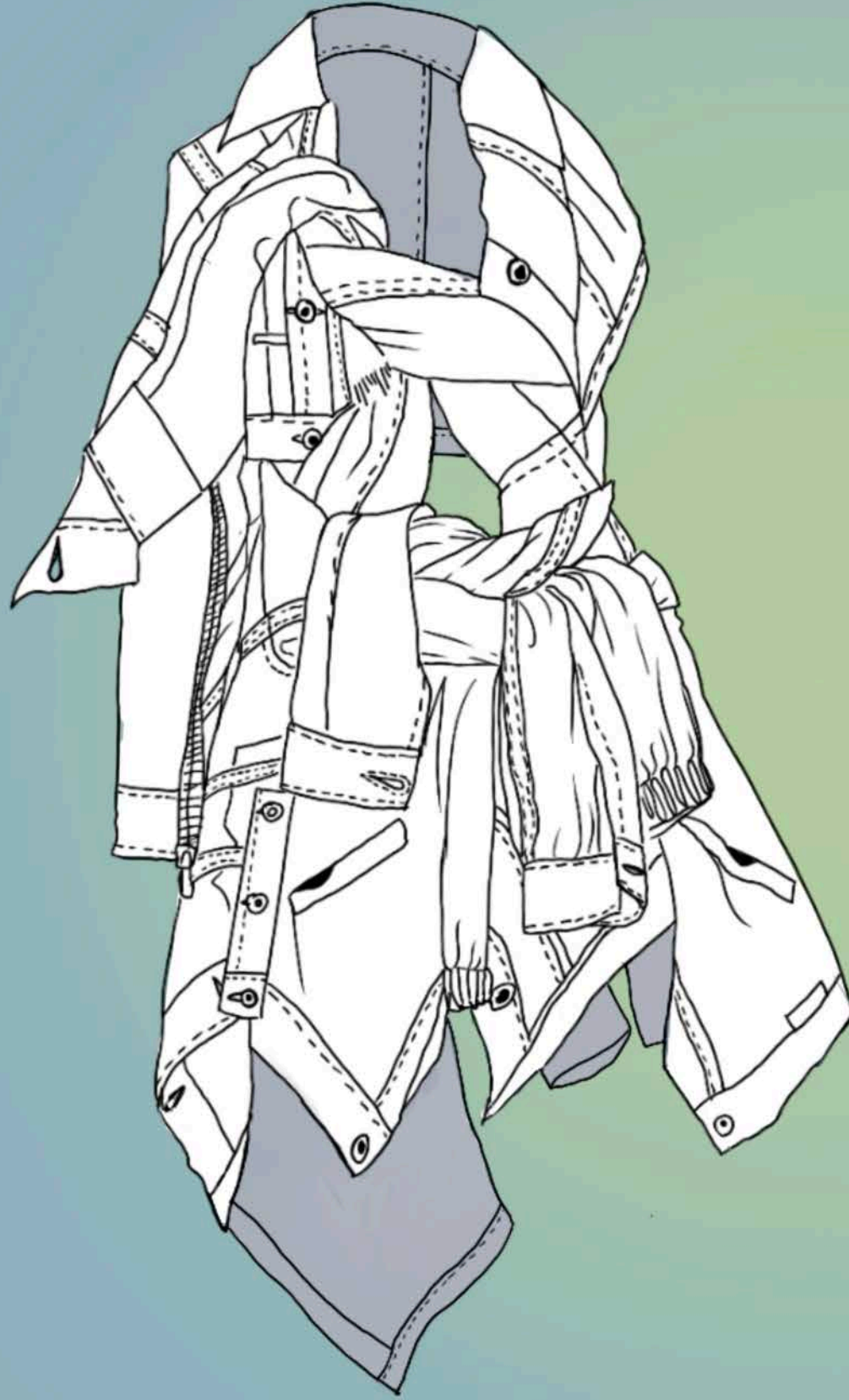

O
P
E
N

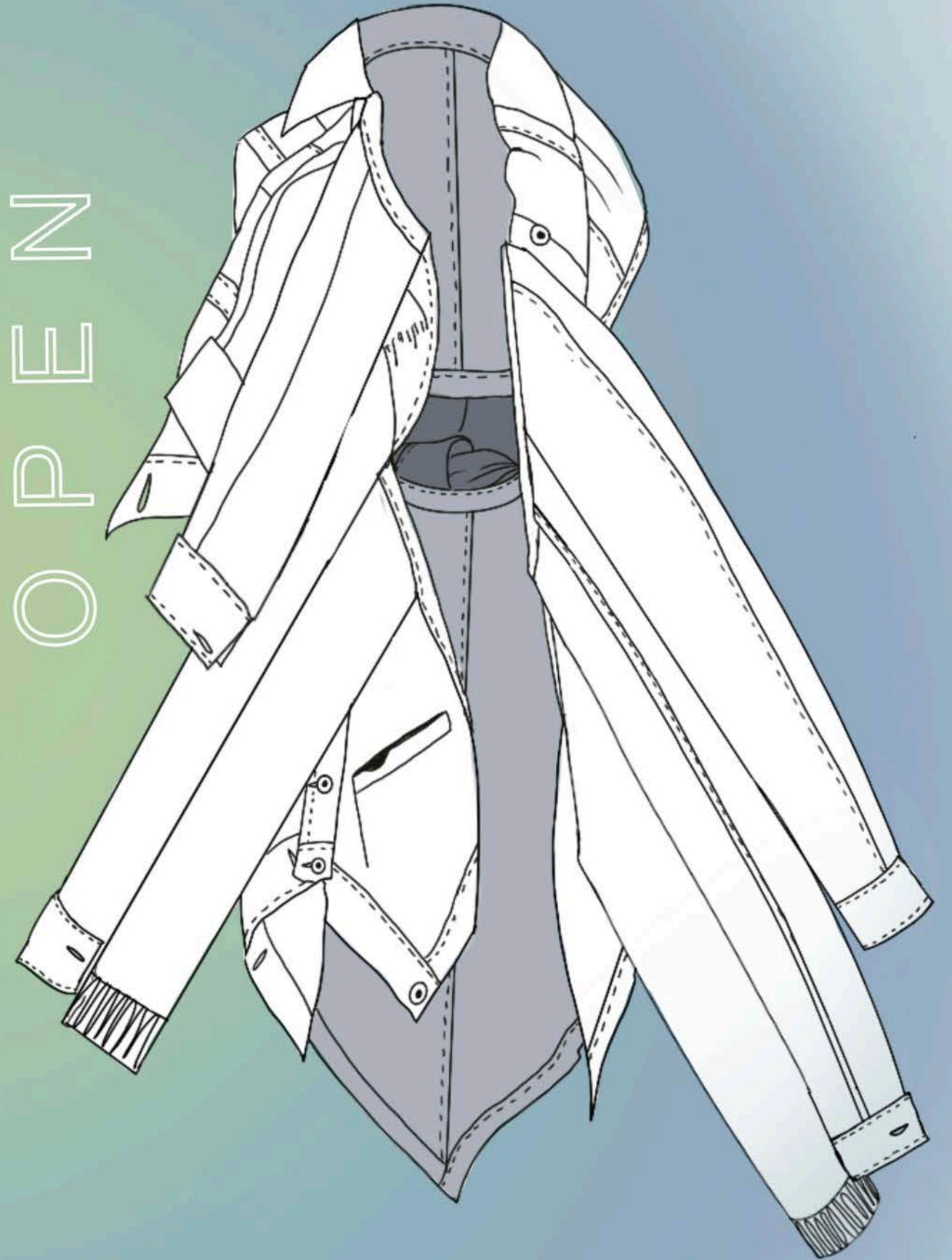

F
R
O
N
T



B

A

C

K

C
L
O
S
E
D



O
P
E
N

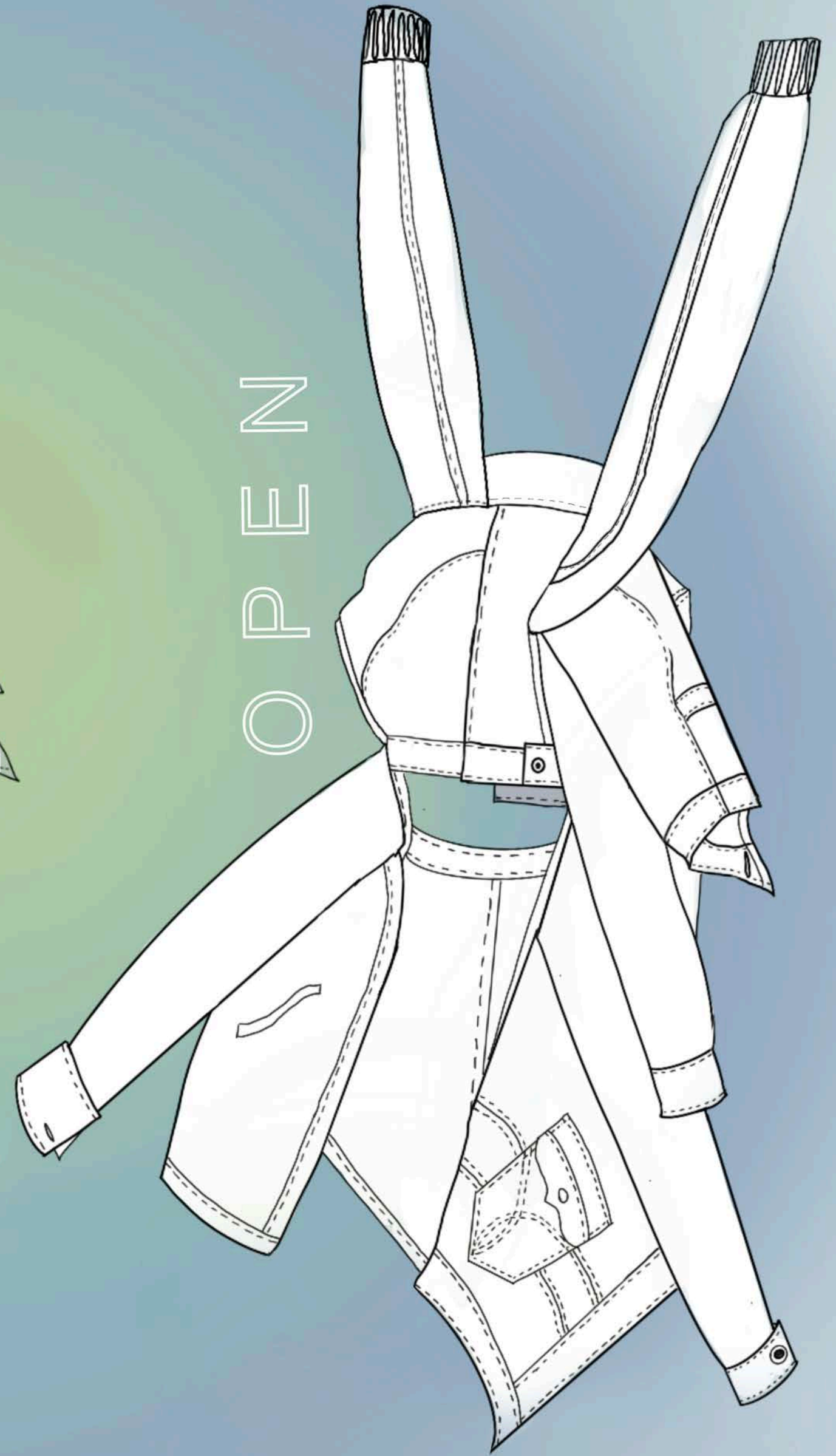

**ONE BAG:
ALL SITUATIONS:
ALL PEOPLE:
ZERO-WASTE**

ELEMENT-Ø



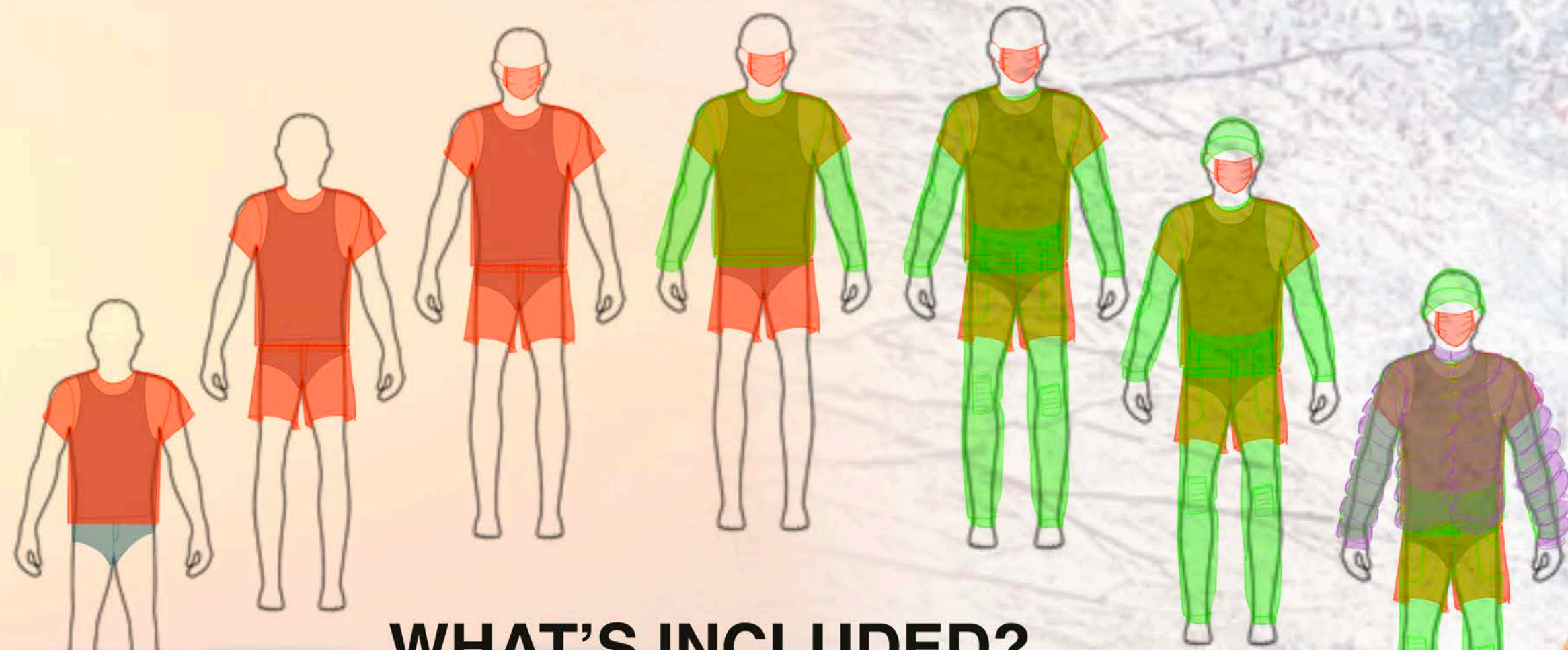

WHAT'S INCLUDED?

1. Under Garments (Top & Bottom) (x 4)
2. Cotton T-Shirt & Shorts (x 4)
3. Sweatshirt & Sweat Pants (x 1)
4. Insulated/Compactible Jacket (x 1)
5. Water Proof Parka & Windbreaker Pants (x 1)
6. Mask & Hat (x 1)
7. Bag (x 1)

ALL ZERO-WASTE

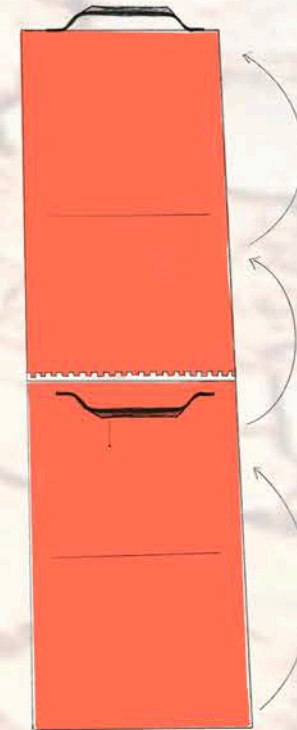
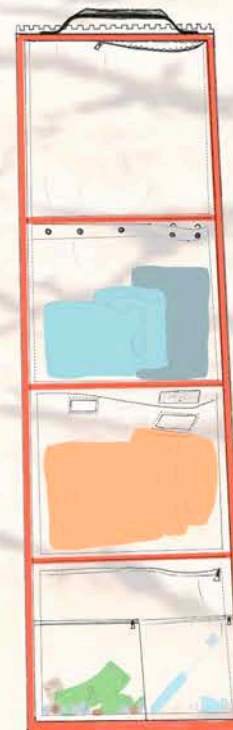
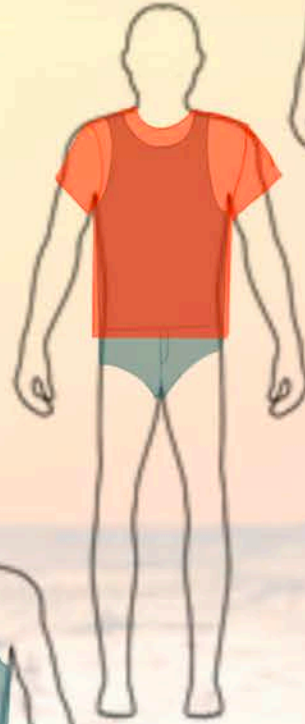
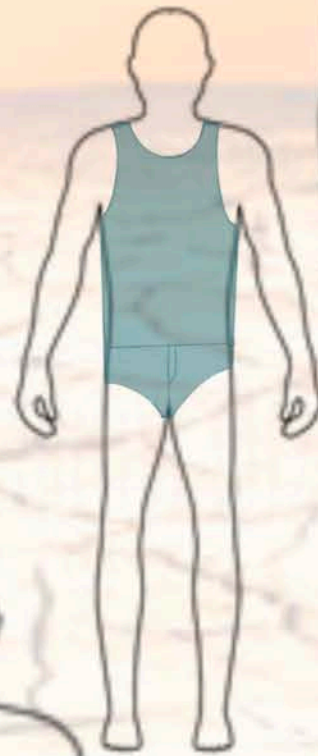
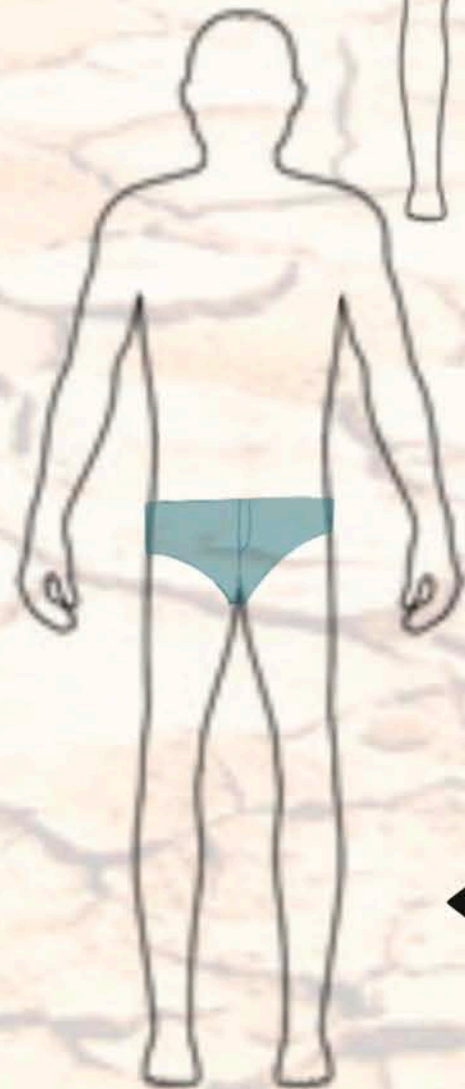

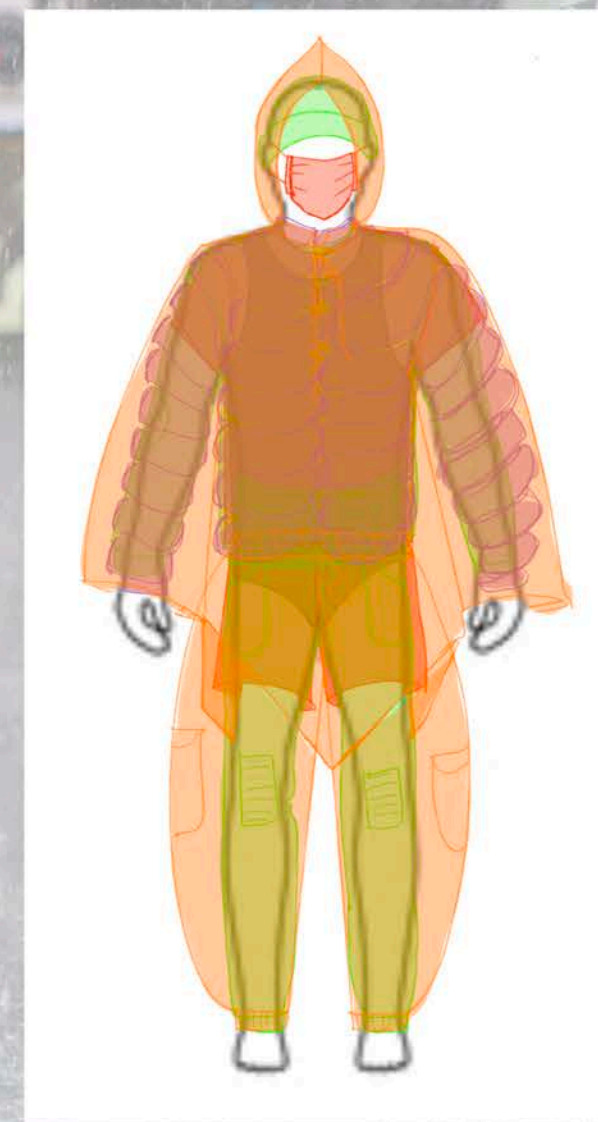
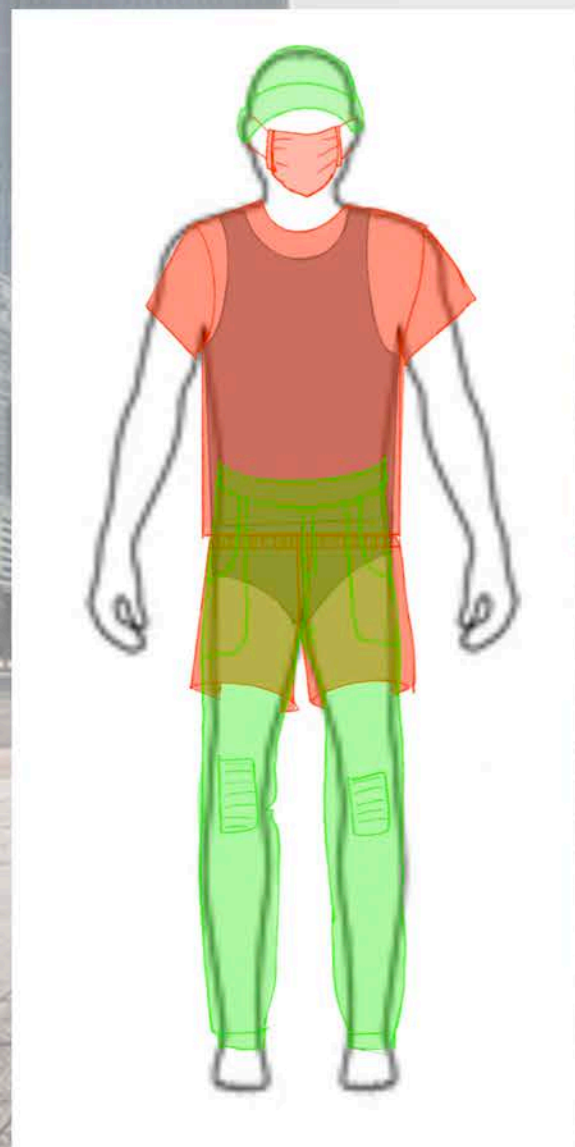
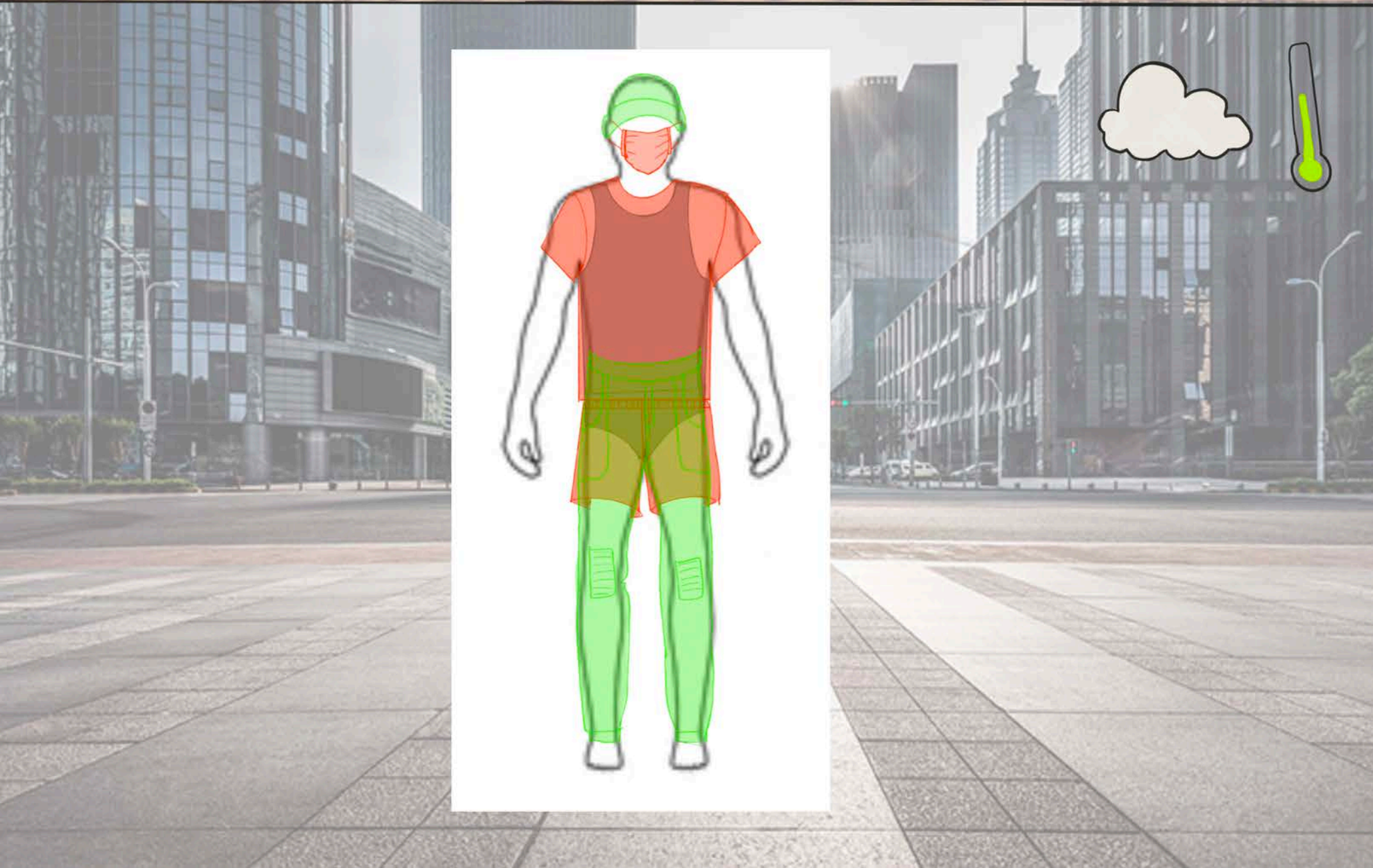
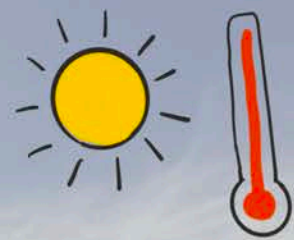
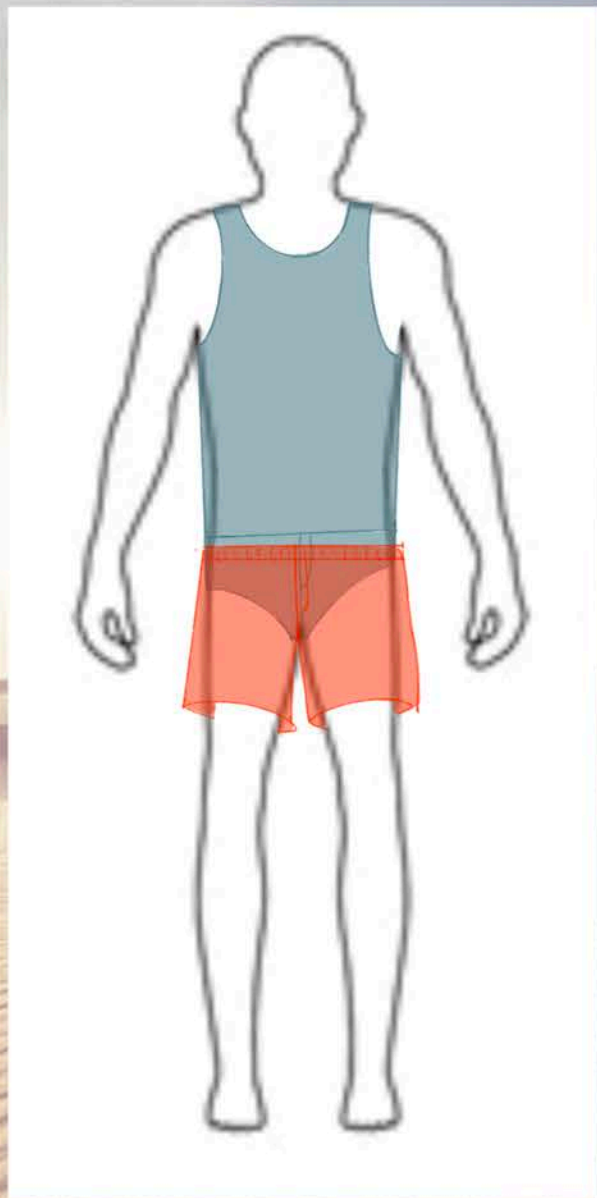
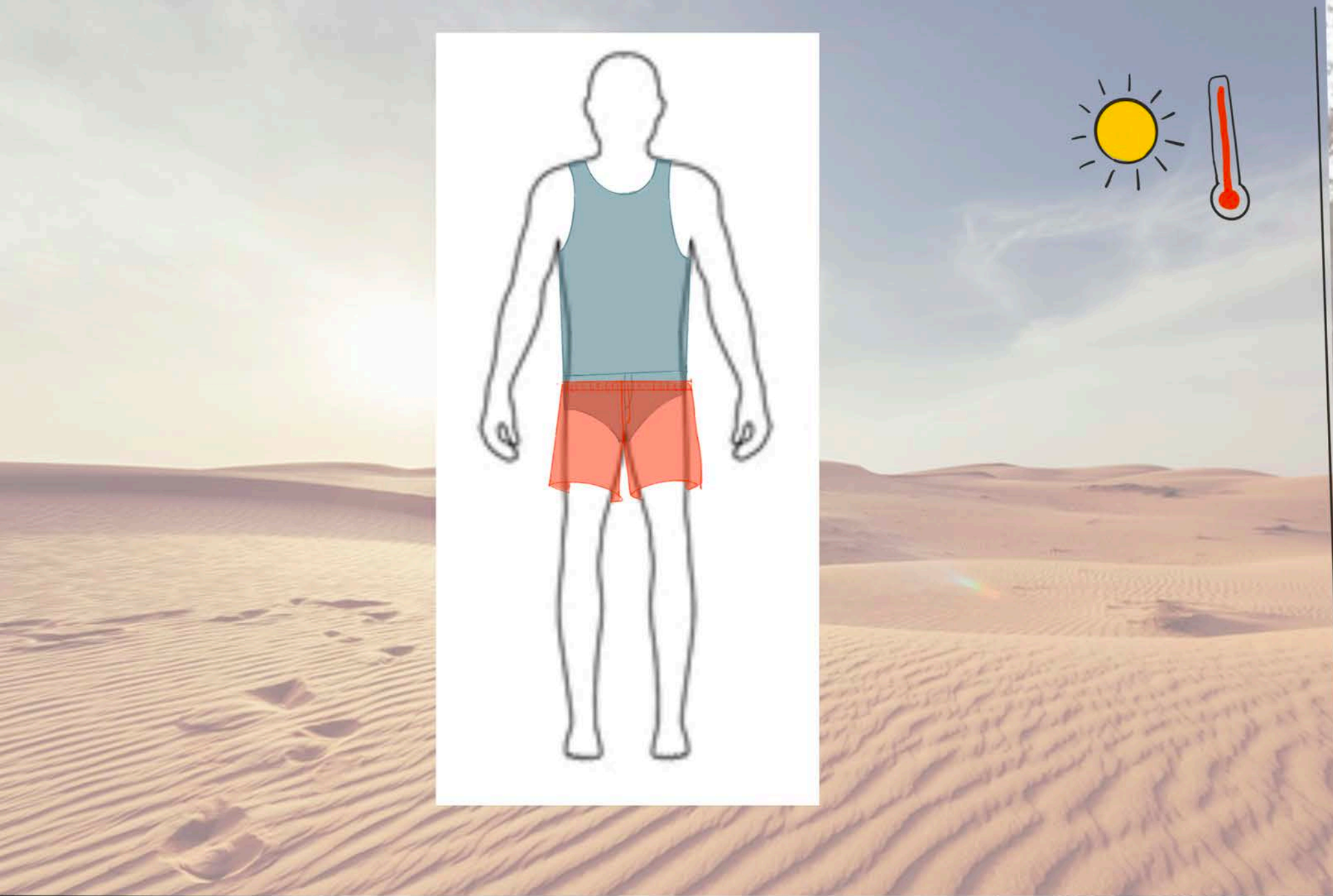

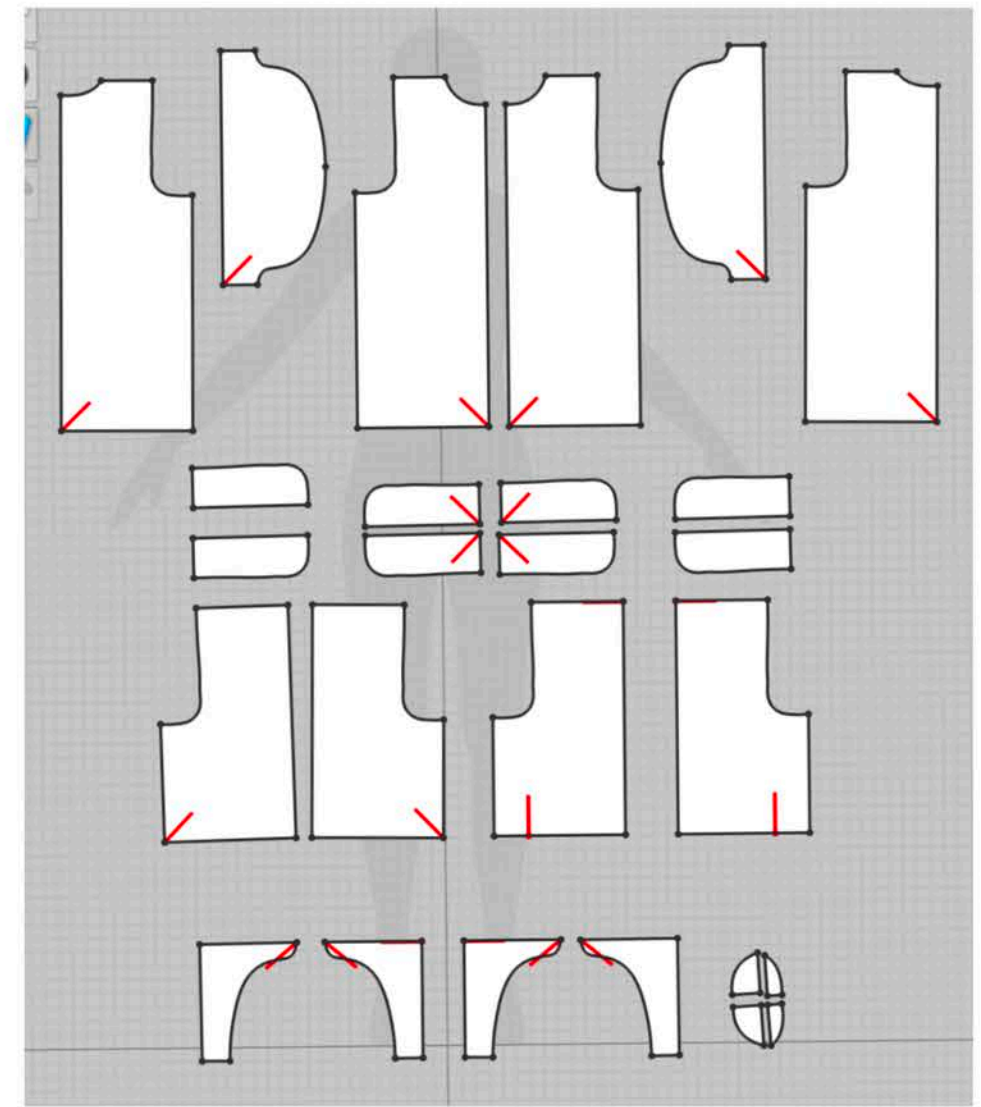
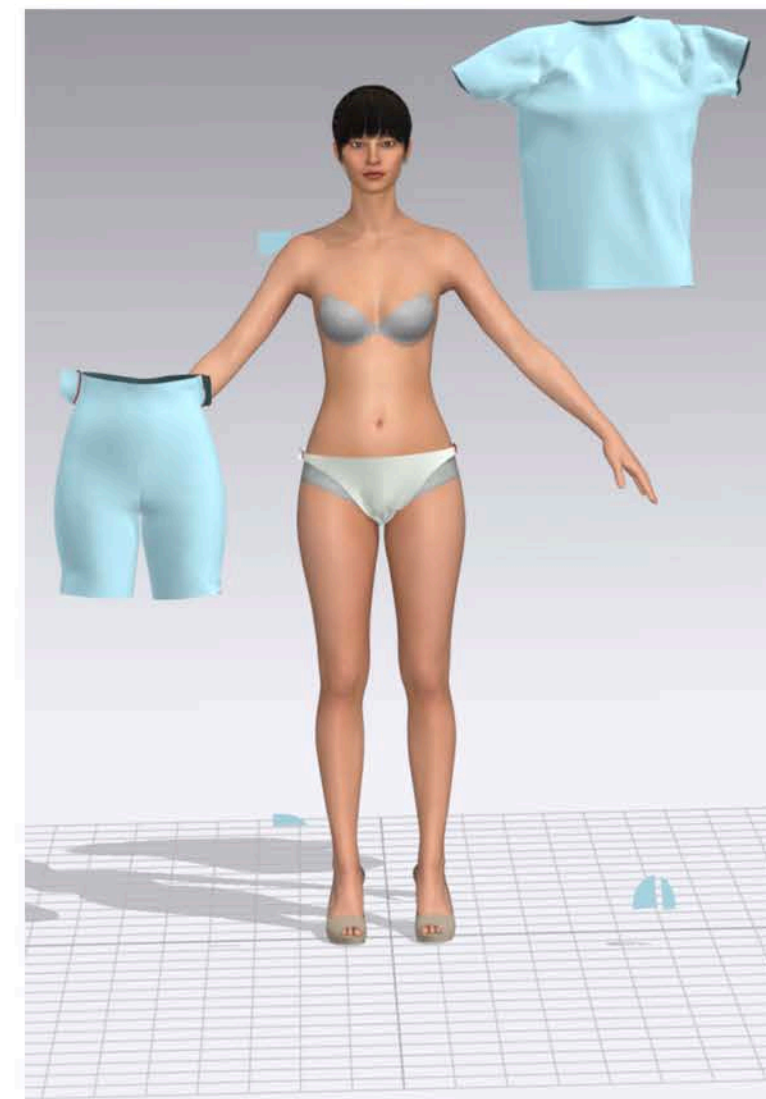
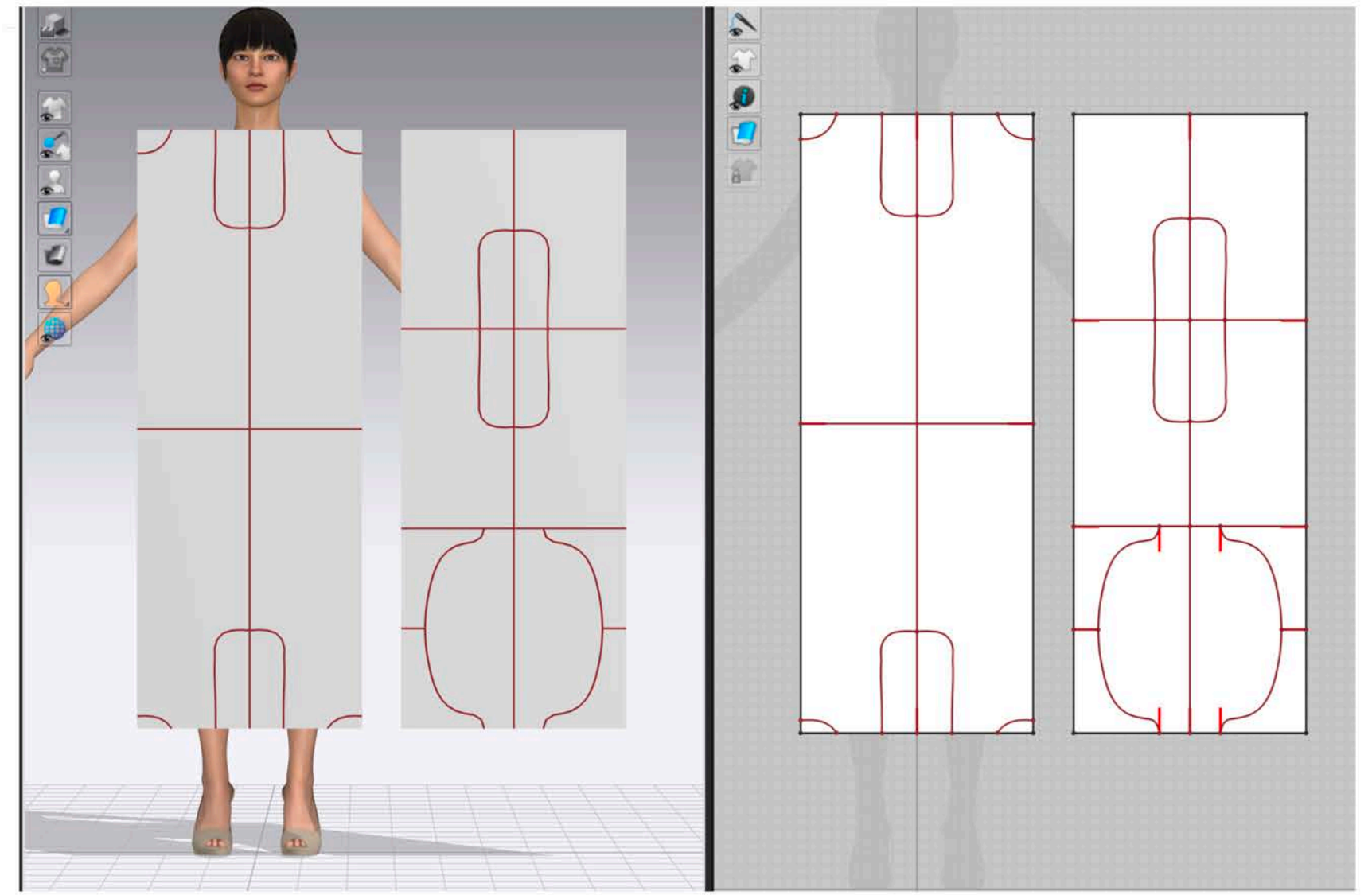
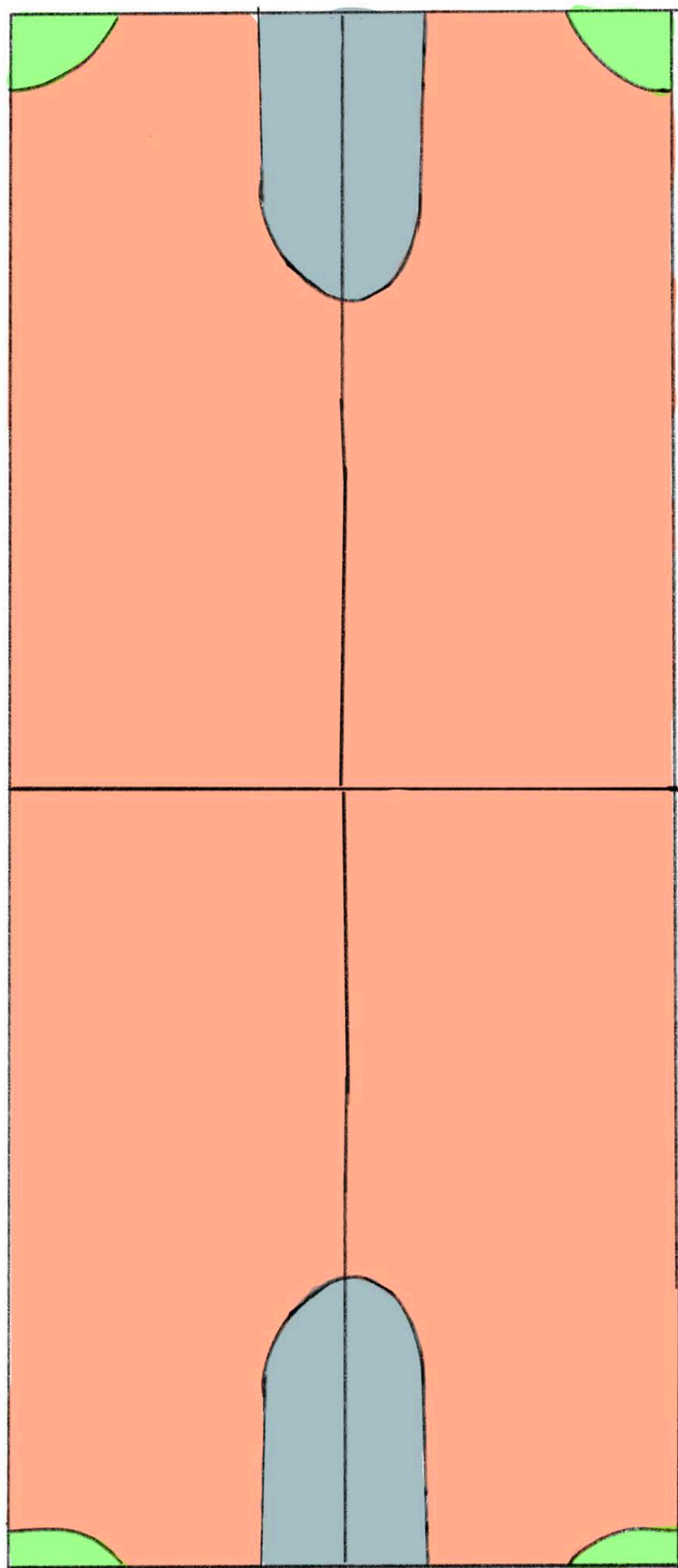
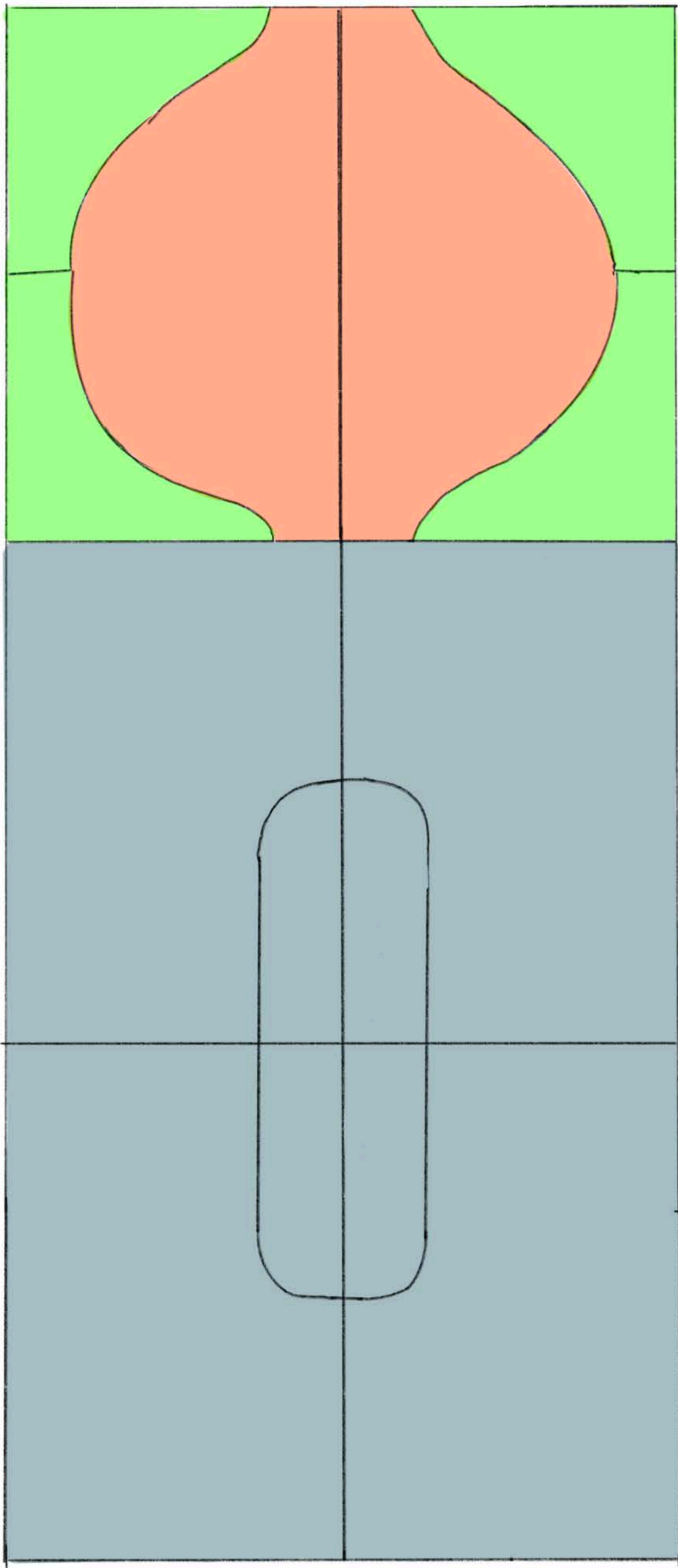

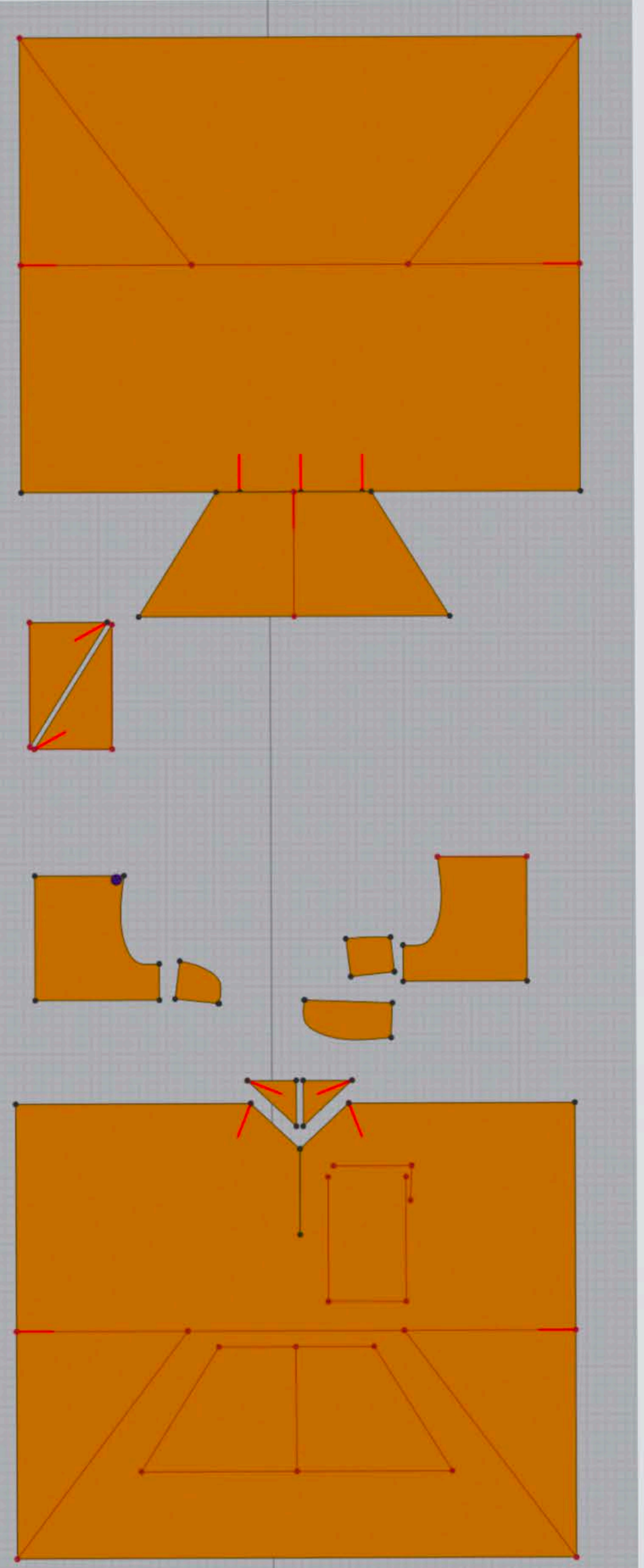

THANK YOU

CONTACT INFO:

(228) 596-8595

www.hardcandidesign.com

candiskyegordon@gmail.com

Instagram: @hard_candi_design